

V R C 6 9 4 0 T e r m i n a l



symbol[®]



© 2001-2002 SYMBOL TECHNOLOGIES, INC. All rights reserved.

Symbol reserves the right to make changes to any product to improve reliability, function, or design.

Symbol does not assume any product liability arising out of, or in connection with, the application or use of any product, circuit, or application described herein.

No license is granted, either expressly or by implication, estoppel, or otherwise under any patent right or patent, covering or relating to any combination, system, apparatus, machine, material, method, or process in which Symbol products might be used. An implied license exists only for equipment, circuits, and subsystems contained in Symbol products.

Symbol and the Symbol logo are registered trademarks of Symbol Technologies, Inc. Other product names mentioned in this manual may be trademarks or registered trademarks of their respective companies and are hereby acknowledged.

Symbol Technologies, Inc.

One Symbol Plaza

Holtsville, N.Y. 11742-1300

<http://www.symbol.com>

Patents

This product is covered by one or more of the following U.S. and foreign Patents:

U.S. Patent No. 4,593,186; 4,603,262; 4,607,156; 4,652,750; 4,673,805; 4,736,095;
4,758,717; 4,760,248; 4,806,742; 4,816,660; 4,845,350; 4,896,026; 4,897,532; 4,923,281;
4,933,538; 4,992,717; 5,015,833; 5,017,765; 5,021,641; 5,029,183; 5,047,617; 5,103,461;
5,113,445; 5,130,520; 5,140,144; 5,142,550; 5,149,950; 5,157,687; 5,168,148; 5,168,149;
5,180,904; 5,216,232; 5,229,591; 5,230,088; 5,235,167; 5,243,655; 5,247,162; 5,250,791;
5,250,792; 5,260,553; 5,262,627; 5,262,628; 5,266,787; 5,278,398; 5,280,162; 5,280,163;
5,280,164; 5,280,498; 5,304,786; 5,304,788; 5,306,900; 5,324,924; 5,337,361; 5,367,151;
5,373,148; 5,378,882; 5,396,053; 5,396,055; 5,399,846; 5,408,081; 5,410,139; 5,410,140;
5,412,198; 5,418,812; 5,420,411; 5,436,440; 5,444,231; 5,449,891; 5,449,893; 5,468,949;
5,471,042; 5,478,998; 5,479,000; 5,479,002; 5,479,441; 5,504,322; 5,519,577; 5,528,621;
5,532,469; 5,543,610; 5,545,889; 5,552,592; 5,557,093; 5,578,810; 5,581,070; 5,589,679;
5,589,680; 5,608,202; 5,612,531; 5,619,028; 5,627,359; 5,637,852; 5,664,229; 5,668,803;
5,675,139; 5,693,929; 5,698,835; 5,705,800; 5,714,746; 5,723,851; 5,734,152; 5,734,153;
5,742,043; 5,745,794; 5,754,587; 5,762,516; 5,763,863; 5,767,500; 5,789,728; 5,789,731;
5,808,287; 5,811,785; 5,811,787; 5,815,811; 5,821,519; 5,821,520; 5,823,812; 5,828,050;
5,848,064; 5,850,078; 5,861,615; 5,874,720; 5,875,415; 5,900,617; 5,902,989; 5,907,146;
5,912,450; 5,914,478; 5,917,173; 5,920,059; 5,923,025; 5,929,420; 5,945,658; 5,945,659;
5,946,194; 5,959,285; 6,002,918; 6,021,947; 6,029,894; 6,031,830; 6,036,098; 6,047,892;
6,050,491; 6,053,413; 6,056,200; 6,065,678; 6,067,297; 6,082,621; 6,084,528; 6,088,482;
6,092,725; 6,101,483; 6,102,293; 6,104,620; 6,114,712; 6,115,678; 6,119,944; 6,123,265;
6,131,814; 6,138,180; 6,142,379; 6,172,478; 6,176,428; 6,178,426; 6,186,400; 6,188,681;
6,209,788; 6,209,789; 6,216,951; 6,220,514; 6,243,447; 6,244,513; 6,247,647; 6,308,061;
6,250,551; 6,295,031; 6,308,061; 6,308,892; 6,321,990; 6,328,213; 6,330,244; 6,336,587;
6,340,114; 6,340,115; 6,340,119; 6,348,773; 6,380,949; 6,394,355; D305,885; D341,584;
D344,501; D359,483; D362,453; D363,700; D363,918; D370,478; D383,124; D391,250;
D405,077; D406,581; D414,171; D414,172; D418,500; D419,548; D423,468; D424,035;
D430,158; D430,159; D431,562; D436,104.

Invention No. 55,358; 62,539; 69,060; 69,187, NI-068564 (Taiwan); No. 1,601,796; 1,907,875;
1,955,269 (Japan); European Patent 367,299; 414,281; 367,300; 367,298; UK 2,072,832; France
81/03938; Italy 1,138,713

rev. 06/02

Introduction

The VRC 6940 is a rugged computer terminal that can be installed in a vehicle or mounted on a wall or workbench. It allows you to gather information quickly, easily and accurately using the keyboard or an attached scanner. The VRC 6940 transfers the information to a base station Access Point (AP) through a Symbol Spectrum24[®] radio network. Then the AP transmits that information to a host computer for processing.

VRC 6940 terminals can run a variety of software applications. For help in using an application at your facility, refer to the application documentation or ask your System Administrator.

About This Guide

This manual describes how to use a VRC 6940 terminal that has been installed in a vehicle or mounted on a wall or workbench. Specific topics include:

- [Parts of a VRC 6940 Terminal on page 2](#)
- [Basic Operation on page 3](#)
- [Modifier Keys: SHIFT, FUNC and CTRL on page 4](#)
- [Resetting the Terminal on page 4](#)
- [Entering Data on page 5](#)
- [Charging the Internal Battery on page 6](#)
- [Moving to a Different Power Source on page 6](#)
- [Troubleshooting on page 7](#)
- [Installing a VRC 6940 Terminal on page 8](#)

This guide does not describe how to download or install applications, and it does not provide instructions for using specific applications. For more technical information on the VRC 6940 terminal, see the *VRC 6940 Product Reference Guide* (Symbol part number 72-37641-XX).



Parts of a VRC 6940 Terminal

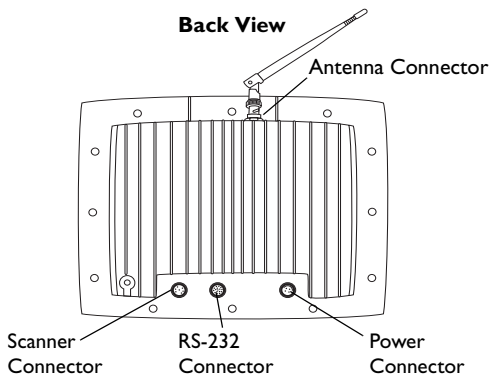
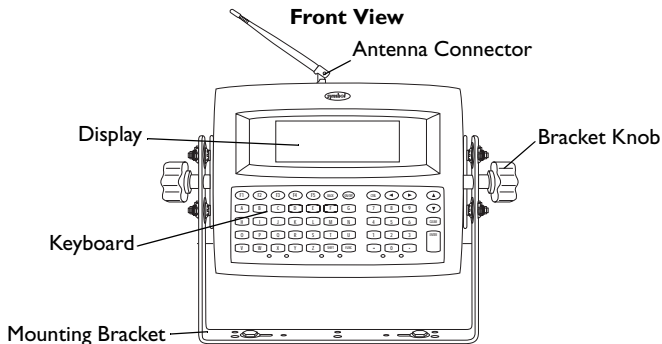

Standard Accessories

The VRC 6940 comes with these items:

- Attached vehicle-mount bracket
- Bracket knobs (2)
- External DC power cable.

Optional Accessories

You can order these optional accessories from Symbol:

- Scanner cable
- RS-232 cable
- Primary antenna
- Vehicle-mounted antenna
- Spectrum24 PCMCIA radio card
- AC universal power supply
- AC cable.

Basic Operation

Turning the Terminal On

1. Press the ON/OFF key located at the top right corner of the alpha section of the keyboard.
2. If the terminal has been configured for your facility, it displays a login screen or main application screen.
3. Follow the instructions for your facility's applications.

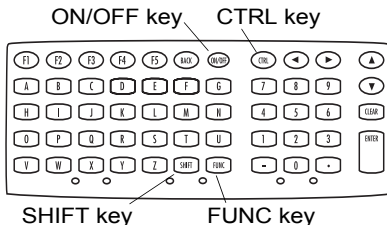

Suspending or Turning Off the Terminal

To suspend the terminal, press the ON/OFF key. The screen goes dark, and the terminal appears to be off. However when you press the ON/OFF key again, the terminal resumes your previous session.

Forcing the Terminal into Suspend

If the terminal does not go into suspend when you press the ON/OFF key, you can force it into suspend. To do this, press and hold the ON/OFF key for 15 seconds, or until the display goes dark.



Turning the Terminal Off

In normal operation, you will not turn the terminal off: you will place it into suspend. The terminal only turns off if you have:

- disconnected the power cable, AND
- allowed the internal battery to run down.

For more information, see [Charging the Internal Battery on page 6](#).

Modifier Keys: SHIFT, FUNC and CTRL

SHIFT, FUNC, and CTRL are modifier keys that you can use to generate a special character or function (see [Basic Operation on page 3](#)). For example, you might press FUNC, J to brighten the display. To do this you would:

1. Press and release the FUNC key.
2. Press and release the J.
3. The display brightens, and the keyboard returns to normal functioning.

Adjusting Brightness

Task	Key Sequence	Comment
Brighten the display.	FUNC, J	Repeat the key sequence to reach the desired brightness level. There are seven brightness levels.
Darken the display.	FUNC, I	
Toggle keyboard backlight on or off.	FUNC, K	Not all terminals include a keyboard backlight option.

Resetting the Terminal

You may need to reset a terminal that has stopped responding to keystrokes or to the ON/OFF key, or if it has been forced into suspend. To reset a terminal:

1. Press and hold both the SHIFT key and the L key.
2. Press and release the ON/OFF key.
3. Release the SHIFT and L keys.

Q u i c k R e f e r e n c e

The terminal restarts and you can log in to an application. If you have problems opening an application after resetting the terminal, contact your System Administrator.

Note: If you reset a terminal, you may lose any unsaved data.

Entering Data

You can enter data into a VRC 6940 terminal by using the keyboard or an attached scanner.

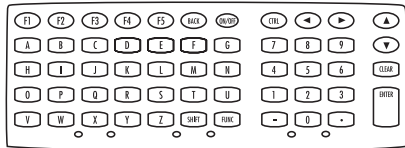

Tips for Using the Keyboard

- **Press only one key at a time.** Pressing two or more keys at the same time can cause an error.
- **Press the keys in correct sequence.** When key sequences are listed for an application, press the keys one at a time in the order they are listed.
- **Auto-repeat feature.** Some applications use the auto-repeat feature of the keyboard. If they do, when you press and hold a key, the key will repeat until you release it.
- **Application functions.** The keyboard may have different functions depending on the application you are using. Refer to your application documentation for more information.

Attaching a Scanner

1. Press the ON/OFF key to suspend the terminal.
2. Fit the scanner cable into the Scanner Connector on the rear of the terminal.

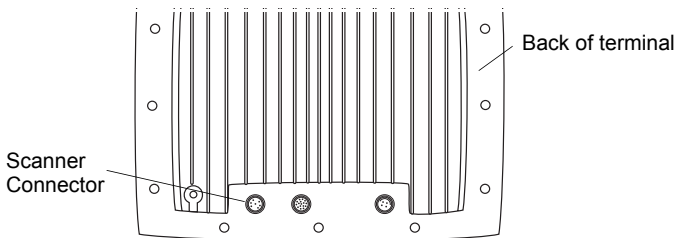

3. Press the ON/OFF key to power the terminal on.
4. For information on using the scanner, consult the documentation that came with the scanner.

Charging the Internal Battery

The VRC 6940 has an internal battery that provides power and saves your session if there is a temporary fluctuation, disconnection, or interruption in the unit's main power supply. The internal battery recharges itself from the terminal's main power supply. You cannot use it to operate the unit. For more information, see [Installation and the Internal Battery on page 16](#).

Moving to a Different Power Source

To move a VRC 6940 terminal from one location to another:

1. Save all data you are working with, and close all applications.
2. Press the ON/OFF key to suspend the terminal.
3. Make sure a power source is ready in the new location.
4. Unplug the external power cable from the Power Connector on the back of the terminal.
5. Remove the terminal from its current mounting.
6. Move the terminal to the new location and mount it.
7. Plug the external power cable into the Power Connector.

For more information on installation and power, see [page 8](#).

Q u i c k R e f e r e n c e

Note: If you unplug the power cable, and the internal battery is not charged, the terminal may shut off.

Troubleshooting

Problem	Action
The terminal will not start.	Make sure that the terminal is connected to a power source. If the external power cable has come unplugged, plug it back in and press the ON/OFF key to restart the terminal. If the internal battery was charged, the terminal will maintain your session until you reconnect it to the power source and restart it. If the internal battery was <i>not</i> fully charged, you may have lost any unsaved data.
	If the terminal is connected to a vehicle battery as a power source, check the vehicle battery. If it is depleted (dead), replace the vehicle battery.
The start-up process fails.	The terminal may be out of range of the Access Point (AP) and unable to communicate with the host computer. Move closer to the AP.
	If either of these messages appears, contact your System Administrator: Boot server doesn't exist. Boot server not configured for this terminal.
Application does not respond.	The terminal may not be connecting to the Access Point (AP). Applications function until they need to transmit to the AP, then they stop responding. Contact your System Administrator.
Scanner laser works but does not read bar codes.	The bar code on the label may not be clearly printed. Try scanning another label of the same product, or type in the bar code data manually.
	The scanner window may be dirty. Clean it with a soft, dry cloth moistened with an ammonia-based glass cleaner.
Scanner does not operate.	Make sure the scanner is properly connected to the terminal's Scanner Connector. Then restart the terminal with the scanner connected.



Problem	Action
Power fault.	<p>This message may appear if the terminal's last shutdown was caused by power failure. A power failure can be caused by:</p> <ul style="list-style-type: none"> • removing the terminal from the power source • removing the vehicle battery • sudden main battery failure <p>If the internal battery is charged, it can maintain session data for up to 72 hours. You can replace the main power supply and restart the terminal without losing data.</p> <p>If the internal battery is not fully charged, the terminal may not be able to maintain session data, and you will lose any unsaved data. To recharge the internal battery, keep the main power connected to the unit for 48 hours.</p>
Terminal suddenly shuts off or goes into suspend.	<p>The terminal may be in suspend mode. Press the ON/OFF key to reactivate it.</p> <hr/> <p>Check the main power supply and external power cable. If the cable is unplugged, plug it back in and press the ON/OFF key to restart the terminal.</p> <p>If the terminal loses its connection with its main power source, it goes into suspend. The internal battery can maintain session data for up to 72 hours. However if the internal battery is not fully charged, the terminal may not maintain your session, and you may lose unsaved data. For more information, see Charging the Internal Battery on page 6 and Installation and the Internal Battery on page 16.</p>

Installing a VRC 6940 Terminal

This section describes how to install a VRC 6940 terminal into a vehicle or onto a wall or workbench. Please read all of these instructions before you begin.

WARNING

A properly trained technician must perform the installation. Improper installation can damage your vehicle.

Equipment Required

Vehicle Mounting

- VRC 6940 terminal.
- an External DC power cable (supplied with terminal).
- minimum of two 3/8" bolts with self-locking nylon nuts.
- a drill with a 7/16" drill bit.
- 7/16" hex wrench.
- a connector for terminating the External DC power cable. Select one that mates with your vehicle's power supply.
- primary or external antenna (optional).

Wall or Workbench Mounting

- VRC 6940 terminal.
- AC universal power supply (Symbol p/n 50-14001-006).
- AC line cable (Symbol p/n 23844-00-00).
- DC power cable (Symbol p/n 25-39385-01).
- minimum of two 3/8" bolts with self-locking nylon nuts.
- a drill with a 7/16" drill bit.
- 7/16" hex wrench.
- primary or external antenna (optional).

Hardware Installation

The physical requirements of the work area affect where you place the terminal. There are different installation options, depending on where you plan to locate it. Illustrations on page 12 and 13 show a terminal mounted on a vehicle, a terminal mounted on a wall, and a terminal mounted on a workbench.

Caution: Do not install a VRC 6940 terminal in a location that will affect vehicle safety or driveability.



To install VRC 6940 hardware:

1. Prepare a mounting location:
 - a. Select a location to mount the terminal. The terminal's attached bracket has holes cut for bolts. Use these holes to mark bolt hole locations.
 - b. Prepare the mounting surface to accept two 3/8" bolts. Drill two holes with a 7/16" drill bit.

Installation Note: Selecting a Mounting Location

The bracket and terminal must be:

- firmly secured to a surface that can support the weight of the terminal — on a vehicle, wall or workbench
- secured with a minimum of two 3/8" diameter bolts and nylon self-locking nuts
- easy for the end-user to see and reach

2. Install the terminal onto the mounting surface:
 - a. Position the terminal on the mounting surface.
 - b. Fasten it using a minimum of two 3/8" self-locking nuts.

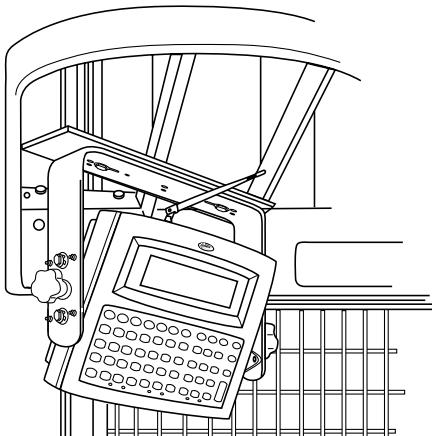

Q u i c k R e f e r e n c e

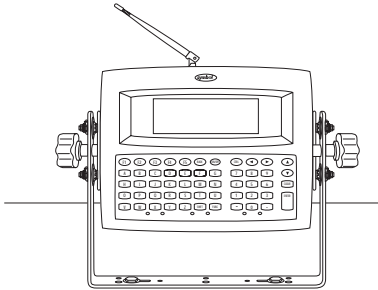
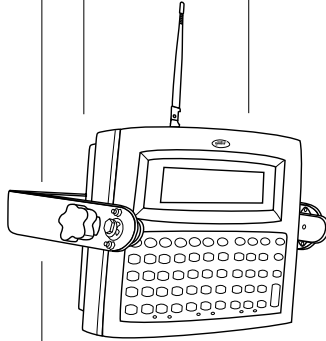

3. Attach the Bracket Knobs. When you first unpack it, the terminal has hex bolts in place of the Bracket Knobs. These knobs allow users to adjust the angle of the terminal.
 - a. Use a 7/16" hex wrench to remove the bolts and replace them with the Bracket Knobs.

- b. To adjust the angle of the display, partially unscrew the Bracket Knobs. Then adjust the angle of the terminal and re-tighten them.
4. Optional: attach a primary antenna to the connector at the top of the terminal. To attach the antenna:
 - a. Place the metal end of the antenna onto the connector.
 - b. Line the posts up with the connector and press down.
 - c. Twist the bottom ring clockwise to lock it into position.

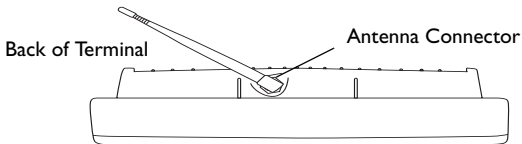

5. Optional: install a vehicle-mounted antenna. Sometimes you can improve wireless communication by mounting an external antenna onto the vehicle. Symbol has several different external antennas available. Contact your Support Representative for more information.

To connect an external vehicle-mounted antenna:

- a. Secure the external antenna to an appropriate location on the vehicle.

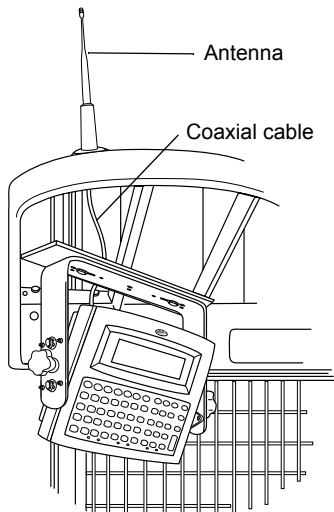

Q u i c k R e f e r e n c e

- b. Connect one end of a coaxial cable to the terminal's Antenna Connector. Connect the other end to the vehicle-mounted antenna. Make the coaxial cable as short as possible to minimize signal loss.

Providing Power: Vehicle Installations

VRC 6940 terminals can be powered by:

- 12V or 24V gas-powered vehicles
- battery-powered vehicles, up to 60 volts

To provide power to a vehicle-installed VRC 6940:

1. Locate your vehicle's power source. Always connect a VRC 6940 terminal to a continuous or unswitched power source.

Installation Note: Power Sources
The ideal location for connecting a VRC 6940 External DC power cable would be a fused power source on the vehicle's power distribution panel. If no fused power source is available, you can connect the terminal directly to a vehicle battery. In this case, Symbol recommends that you use an in-line fuse holder and 5A slow-blow fuse. The fuse protects your vehicle from an electrical short on the power cable.

2. Prepare the External DC power cable. One end of the external DC power cable fits into the terminal's DC Power connector. The other end has no connector.

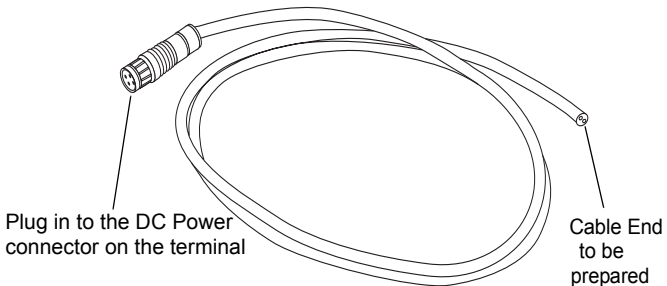

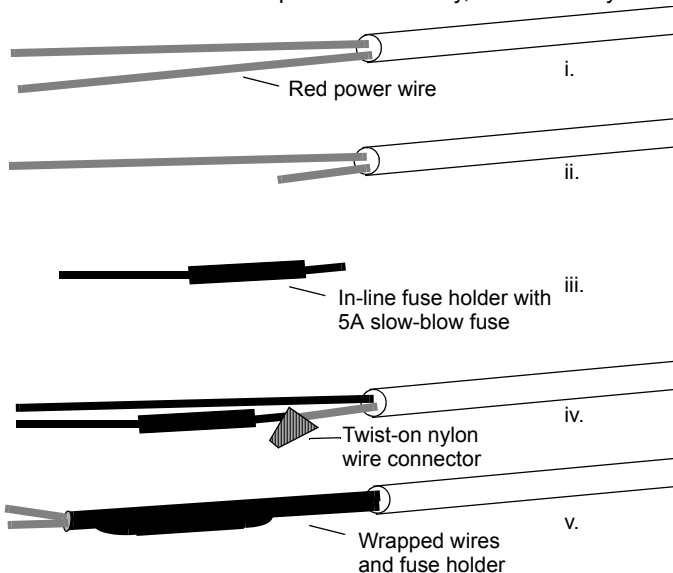

To prepare the end of the External DC power cable:

- a.  **In-line fuse holder: if no fused output is available, add a fuse-holder and 5 Amp fuse to the External DC power cable:**
- Strip back six inches of the cable jacket.
 - Cut about 5" from the red power wire and strip 3/8" insulation from the wire.
 - Strip 3/8" insulation from the fuse-holder wire.
 - Twist the stripped wire ends together and splice them using a twist-on nylon wire connector.
 - Make sure the fuse holder contains a 5 Amp slow-blow fuse. Wrap the wires neatly, as necessary.



Q u i c k R e f e r e n c e

- b. Route the External DC power cable from the terminal location to the connection point for your vehicle's power source.

 Installation Note: Cable Routing Caution 

<p>The means of routing and securing the External DC power cable from the terminal to the vehicle power source is extremely important. Hazards associated with improper wiring can be severe.</p> <p>To avoid unintentional contact between the wire and any sharp edges, provide the cable with proper bushings and clamping where it passes through openings. If the wire is subjected to sharp surfaces and excess engine vibration, the wiring harness insulation can wear away, causing a short between the bare wire and chassis. This can start a fire.</p>
--

- c. Prepare the cable termination: Strip 3/8" of insulation from the two wire ends and terminate them with a connector that matches your vehicle's requirements. See the Installation Note below.

Connect the red wire to the vehicle power source. Connect the black wire to a vehicle ground wire or chassis ground.

Installation Note: Cable Termination

<p>How the cable terminates depends on your vehicle. If your vehicle has a power output connector, then attach a mating connector to the end of the power cable. You may be able to connect to a fuse panel with a commercially available connector. If your vehicle has no power output connector, attach a ring terminal (for a battery post) or blade terminal connector (for a fuse panel).</p> <p>Consult your vehicle Owner's Manual for information on how to access your vehicle's power supply.</p>

- d. Connect the External DC power cable to your vehicle power source.
3. Insert the terminal end of the External DC power cable into the terminal's Power Connector. Align the red dot on the end of the power cable with the red dot on the Power Connector.



WARNING

A Lead Acid battery can leak Hydrogen gas. A spark anywhere near the battery can cause it to explode. Always make your final connection to power as far away from the battery as possible, *i.e.*, connect the power cable to the battery first, then connect it to the terminal.

Providing Power: Wall or Workbench Installations

For wall or bench-mounted terminals, or for operating a terminal while away from a vehicle, you can operate an VRC 6940 from an AC universal power supply. You need the AC universal power supply, an AC line cable, and a DC power cable as listed on [page 9](#).

To provide power from an AC source:

1. Insert the AC line cable into the AC connector on the AC universal power supply.
2. Plug the other end of the AC line cable into an AC wall outlet.
3. Insert the DC power cable into the DC connector on the AC universal power supply.
4. Plug the other end of the cable into the terminal's Power Connector.

Installation and the Internal Battery

A terminal's internal battery may be depleted when you first install it. The internal battery charges itself from the terminal's main power supply (DC or AC).

If the main power supply is stable, you can plug in the terminal and use it immediately. If the main power supply is not stable, there may be power interruptions that cause the terminal to reset itself during its first few hours of operation.

If the terminal resets itself, you may lose unsaved data. To avoid this, we recommend that you plug in the terminal and allow it to charge for two hours before using it.

Q u i c k R e f e r e n c e

It takes 48 hours to fully charge the internal battery. A fully charged internal battery maintains data for up to 72 hours if the unit is disconnected from its main power source. This time is reduced if the radio is in a mode where it maintains continuous communication with a host.

Ergonomic Recommendations

Caution: In order to avoid or minimize the potential risk of ergonomic injury follow the recommendations below. Consult with your local Health & Safety Manager to ensure that you are adhering to your company's safety programs to prevent employee injury.

- Reduce or eliminate repetitive motion
- Maintain a natural position
- Reduce or eliminate excessive force
- Keep objects that are used frequently within easy reach
- Perform tasks at correct heights
- Reduce or eliminate vibration
- Reduce or eliminate direct pressure
- Provide adjustable workstations
- Provide adequate clearance
- Provide a suitable working environment
- Improve work procedures.



Regulatory Information

All Symbol devices are designed to be compliant with rules and regulations in locations they are sold and will be labeled as required.

Any changes or modifications to Symbol Technologies equipment, not expressly approved by Symbol Technologies, could void the user's authority to operate the equipment.

Radio Frequency Interference Requirements



Note: This equipment has been tested and found to comply with the limits for a Class B digital device, pursuant to Part 15 of the FCC rules. These limits are designed to provide reasonable protection against harmful interference in a residential installation.

This equipment generates, uses and can radiate radio frequency energy and, if not installed and used in accordance with the instructions, may cause harmful interference to radio communications. However there is no guarantee that interference will not occur in a particular installation. If this equipment does cause harmful interference to radio or television reception, which can be determined by turning the equipment off and on, the user is encouraged to try to correct the interference by one or more of the following measures:

- Reorient or relocate the receiving antenna
- Increase the separation between the equipment and receiver
- Connect the equipment into an outlet on a circuit different from that to which the receiver is connected
- Consult the dealer or an experienced radio/TV technician for help.

Radio Frequency Interference Requirements - Canada

This device complies with RSS 210 of Industry & Science Canada. Operation is subject to the following two conditions: (1) this device may not cause harmful interference and (2) this device must accept any interference received, including interference that may cause undesired operation.

This Class B digital apparatus complies with Canadian ICES-003.

Cet appareil numérique de la classe B est conforme à la norme NMB-003 du Canada.

Label Marking: The Term "IC:" before the radio certification only signifies that Industry Canada technical specifications were met.



FCC RF Exposure Guidelines

Remote and Standalone Antenna Configurations

To comply with FCC RF exposure requirements, antennas that are mounted externally at remote locations or operating near users at stand-alone desktop of similar configurations must operate with a minimum separation distance of 20 cm from all persons.



Marking and European Union Compliance

RLAN's (2.4GHz) for use through the EEA have the following restrictions:

- Maximum radiated transmit power of 100 mW EIRP in the frequency range 2.400 -2.4835 GHz
- France, equipment is restricted to 2.4465 -2.4835 GHz frequency range
- Belgium outside usage, the equipment is restricted to 2.460 -2.4835 GHz frequency range
- Italy requires a user license for outside usage.

Statement of Compliance

Symbol Technologies, Inc., hereby, declares that this device is in compliance with the essential requirements and other relevant provisions of Directives 1999/5/EC, 89/336/EEC, 73/23/EEC and 95/54/EC. Declaration of Conformities may be obtained from <http://www2.symbol.com/doc/>

Other Countries

Mexico - Restrict Frequency Range to: 2.450 - 2.4835 GHz.

Israel - Restrict Frequency Range to: 2.418 - 2.457 GHz.

Sri Lanka - Restrict Frequency Range to: 2.400 - 2.430 GHz.

V R C 6 9 4 0 T e r m i n a l

A large, light gray watermark with the letters 'QRG' is positioned in the upper center of the page, partially overlapping the main title text.

Q u i c k R e f e r e n c e

Warranty

(A) Seller's hardware Products are warranted against defects in workmanship and materials for a period of twelve (12) months from the date of shipment, provided the Product remains unmodified and is operated under normal and proper conditions. Warranty provisions and durations on software, integrated installed systems, Product modified or designed to meet specific customer specifications ("Custom Products"), remanufactured products, and reconditioned or upgraded products, shall be as provided in the applicable Product specification in effect at the time of purchase or in the accompanying software license. (B) Products may be serviced or manufactured with parts, components, or subassemblies that originate from returned products and that have been tested as meeting applicable specifications for equivalent new material and Products. The sole obligation of Seller for defective hardware Products is limited to repair or replacement (at Seller's option) on a "return to service depot" basis with prior Seller authorization. Shipment to and from Seller will be at Seller's expense, unless no defect is found. No charge will be made to Buyer for replacement parts for warranty repairs. Seller is not responsible for any damage to or loss of any software programs, data or removable data storage media, or the restoration or reinstallation of any software programs or data other than the software, if any, installed by Seller during manufacture of the Product. The aforementioned provisions do not extend the original warranty period of any Product that had either been repaired or replaced by Seller. (C) The above warranty provisions shall not apply to any Product (i) which has been repaired, tampered with, altered or modified, except by Seller's authorized service personnel; (ii) in which the defects or damage to the Product result from normal wear and tear, misuse, negligence, improper storage, water or other liquids, battery leakage or failure to perform operator handling and scheduled maintenance instructions supplied by Seller; (iii) which has been subjected to unusual physical or electrical stress, abuse, or accident, or forces or exposure beyond normal use within the specified operational and environmental parameters set forth in the applicable Product specification; nor shall the above warranty provisions apply to any expendable or consumable items, such as batteries, supplied with the Product. EXCEPT FOR THE WARRANTY OF TITLE AND THE EXPRESS WARRANTIES STATED ABOVE, SELLER DISCLAIMS ALL WARRANTIES ON PRODUCTS FURNISHED HERUNDER INCLUDING ALL IMPLIED WARRANTIES OF MERCHANTABILITY AND FITNESS FOR A PARTICULAR USE. ANY IMPLIED WARRANTIES THAT MAY BE IMPOSED BY LAW ARE LIMITED IN DURATION TO THE LIMITED WARRANTY PERIOD. SOME STATES OR COUNTRIES DO NOT ALLOW A LIMITATION ON HOW LONG AN IMPLIED WARRANTY LASTS OR THE EXCLUSION OR LIMITATION OF INCIDENTAL OR CONSEQUENTIAL DAMAGES FOR CONSUMER PRODUCTS. IN SUCH STATES OR COUNTRIES, FOR SUCH PRODUCTS, SOME EXCLUSIONS OR LIMITATIONS OF THIS LIMITED WARRANTY MAY NOT APPLY. The stated express warranties are in lieu of all obligations or liabilities on the part of Seller for damages, including but not limited to, special, indirect or consequential damages arising out of or in connection with the use or performance of the Product or service. Seller's liability for damages to Buyer or others resulting from the use of any Product or service furnished hereunder shall in no way exceed the purchase price of said Product or the fair market value of said service, except in instances of injury to persons or property.

Service Information

Before you use the unit, it must be configured to operate in your facility's network and run your applications.

If you have a problem running your unit or using your equipment, contact your facility's Technical or Systems Support. If there is a problem with the equipment, they will contact the Symbol Support Center:

United States ¹	1-800-653-5350 1-631-738-2400	Canada	905-629-7226
United Kingdom	0800 328 2424	Asia/Pacific	+65-6796-9600
Australia	1-800-672-906	Austria/Österreich	1-505-5794-0
Denmark/Danmark	7020-1718	Finland/Suomi	9 5407 580
France	01-40-96-52-21	Germany/Deutschland	6074-49020
Italy/Italia	2-484441	Mexico/México	5-520-1835
Netherlands/Nederland	315-271700	Norway/Norge	+47 2232 4375
South Africa	11-8095311	Spain/España	91 324 40 00 Inside Spain
Sweden/Sverige	84452900		+34 91 324 40 00 Outside Spain
Latin America Sales Support	1-800-347-0178 Inside US +1-561-483-1275 Outside US		
Europe/Mid-East Distributor Operations	Contact local distributor or call +44 118 945 7360		

¹Customer support is available 24 hours a day, 7 days a week.

For the latest version of this guide go to: <http://www.symbol.com/manuals>.



72-37640-02
Revision C— October 2002